

Article number: 604133056085

Description: Taper bored timing belt pulley
HTD 56 14M 85 TL 3525

Measures

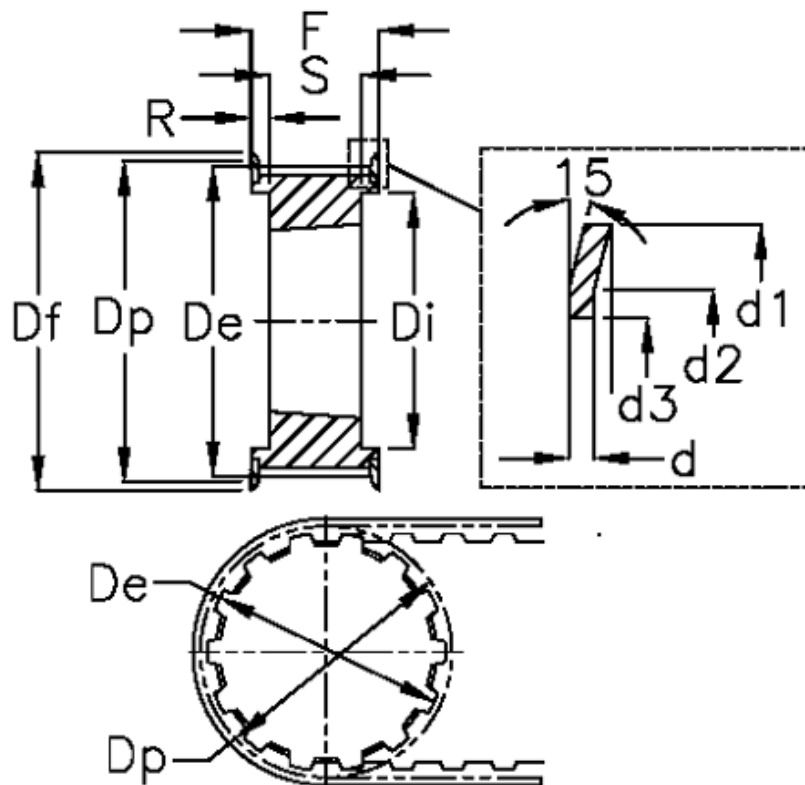

d = 2.5	F = 102	Weight = 19
d1 = 256	Flange type = F66	Width = 85
d2 = 240	For bushing = 3525	
d3 = 220	Max bore = 90	
De = 246.76	r = 18.5	
Df = 256	S = 65	
Di = 210	Tooth number = 56	
Dp = 249.55	Type = 14M	